

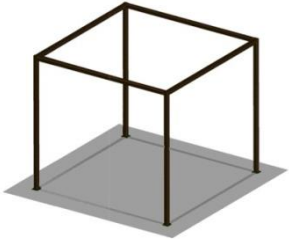

Tecnodeck sistema Pergola.



 **Tecnodeck**[®]



Sistema básico Pérgola:

Base fija

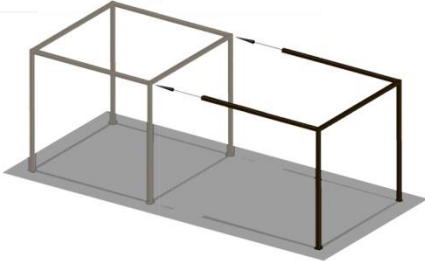

Sistema base Pérgola:

Base fija – adición

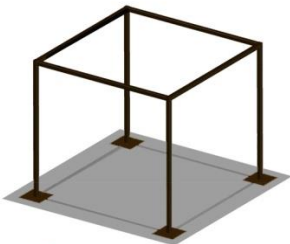

Sistema base Pérgola:

Base amovible

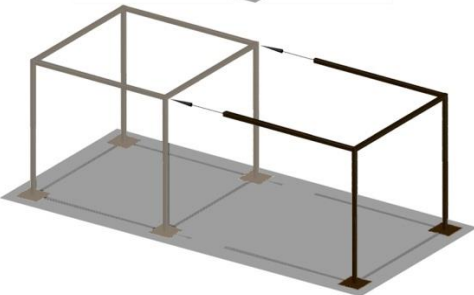

Sistema base Pérgola:

Base – amovible - adición

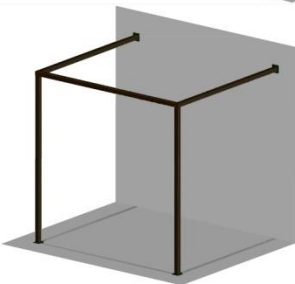

Sistema base Pérgola:

Montaje en la pared

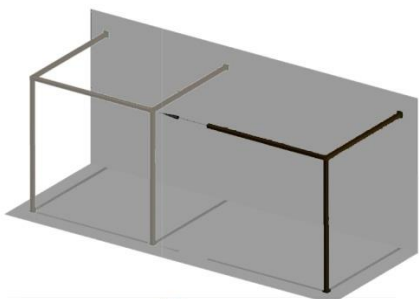

Sistema base Pérgola:

Montaje en la pared - adición

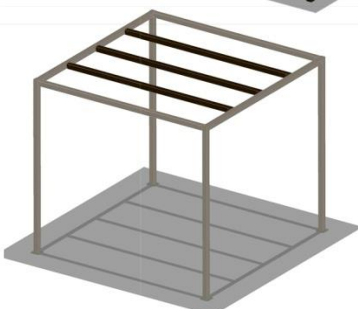







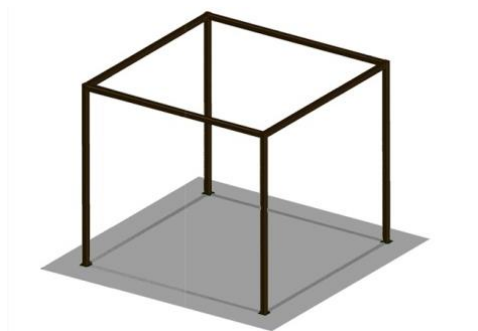

Barra adicional 85x85

Barra Adicional 85x30



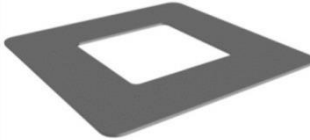



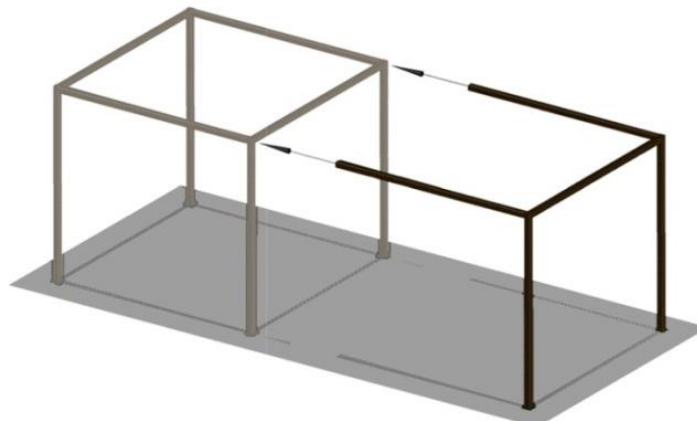

Sistema Básico Pérgola: Base Fija

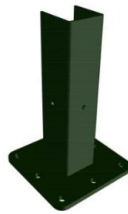

Cantidad	Descripción	Dibujo
8	Perfil Tecnodeck 85x85	
8	Perfil AL 68x68	
4	Base con 8 agujeros [+ tornillos]	
8	Conexión 90° [+ tornillos]	
4	Tapón	
4	Espaciador PE 85x85x5	
Opciones		
4	Brida de acabado con 4 agujeros– Lacada 170x170/2	
	Brida de acabado con 4 agujeros– Acero inoxidable 170x170/2 Inox A4	
44	Tapa atornillada	



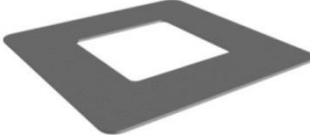



Sistema básico Pérgola: adición

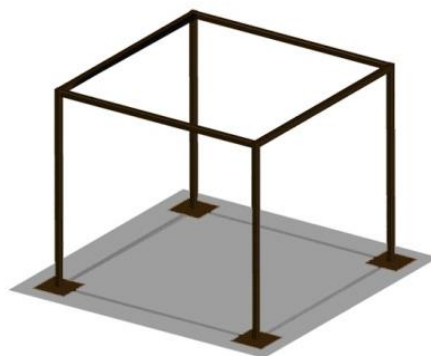

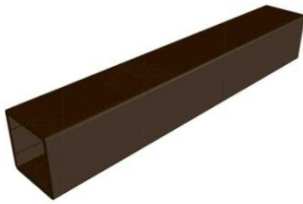
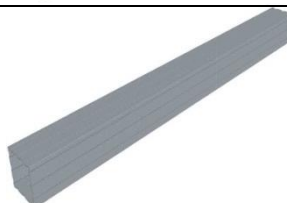
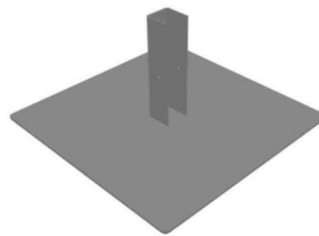
Cantidad	Descripción	Dibujo
5	Perfil Tecnodeck 85x85	
5	Perfil AL 68x68	
2	Base con 8 agujeros [+ tornillos]	
6	Conexión 90° [+ tornillos]	
2	Tapón	
2	Espaciador PE 85x85x5	
Opciones		
2	Brida de acabado con 4 agujeros- Lacada 170x170/2	
	Brida de acabado con 4 agujeros- Acero inoxidable 170x170/2 Inox A4	
30	Tapa atornillada	



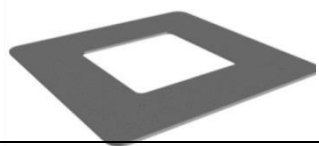



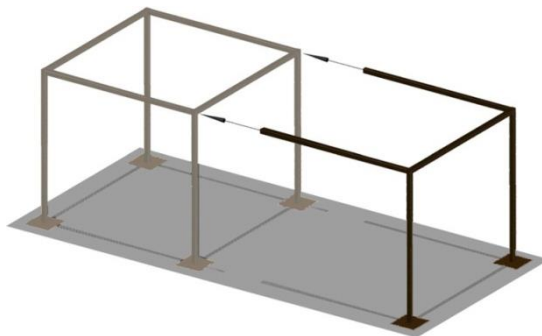

Sistema base Pérgola: Base amovible

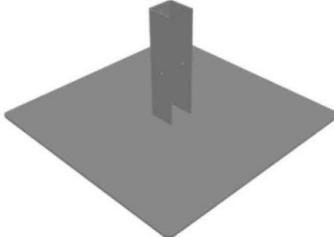

Cantidad	Descripción	Dibujo
8	Perfil Tecnodeck 85x85	
8	Perfil AL 68x68	
4	Base amovible [+ tornillos]	
8	Conexión 90° [+ tornillos]	
4	Tapón	
4	Espaciador PE 85x85x5	
Opciones		
4	Brida de acabado con 4 agujeros– Lacada 170x170/2	
	Brida de acabado con 4 agujeros– Acero inoxidable 170x170/2 Inox A4	
44	Tapa atornillada	



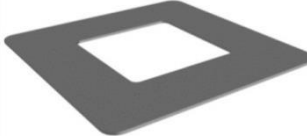



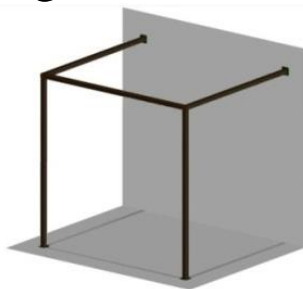

Sistema base Pérgola: base – amovible - adición

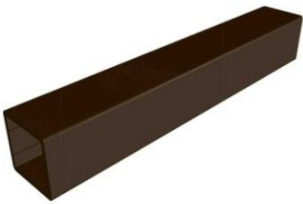

Cantidad	Descripción	Dibujo
5	Perfil Tecnodeck 85x85	
5	Perfil AL 68x68	
2	Base amovible [+ tornillos]	
6	Conexión 90° [+ tornillos]	
2	Tapón	
2	Espaciador PE 85x85x5	
TOTAL		
Opciones 2	Brida de acabado con 4 agujeros– Lacada 170x170/2	
	Brida de acabado con 4 agujeros– Acero inoxidable 170x170/2 Inox A4	
30	Tapa atornillada	



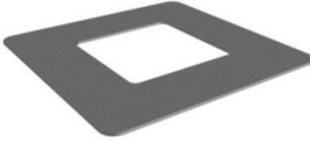



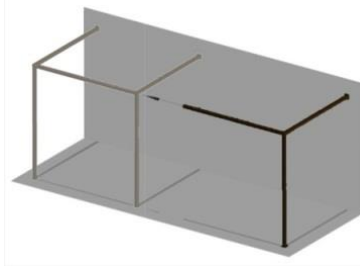

Sistema base Pérgola: Montaje en la pared



Cantidad	Descripción	Dibujo
5	Perfil Tecnodeck 85x85	
5	Perfil AL 68x68	
2	Base con 8 agujeros [+ tornillos]	
2	Terminal p/montaje en pared [+ tornillos]	
4	Conexión 90° [+ tornillos]	
2	Tapón	
2	Espaciador PE 85x85x5	
TOTAL		
Opciones 2	Brida de acabado con 4 agujeros- Lacada 170x170/2	
	Brida de acabado con 4 agujeros- Acero inoxidable 170x170/2 Inox A4	
28	Tapa atornillada	



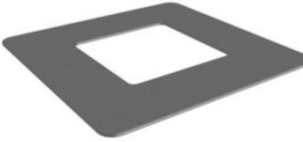



Sistema base Pérgola: montaje a la pared - adición

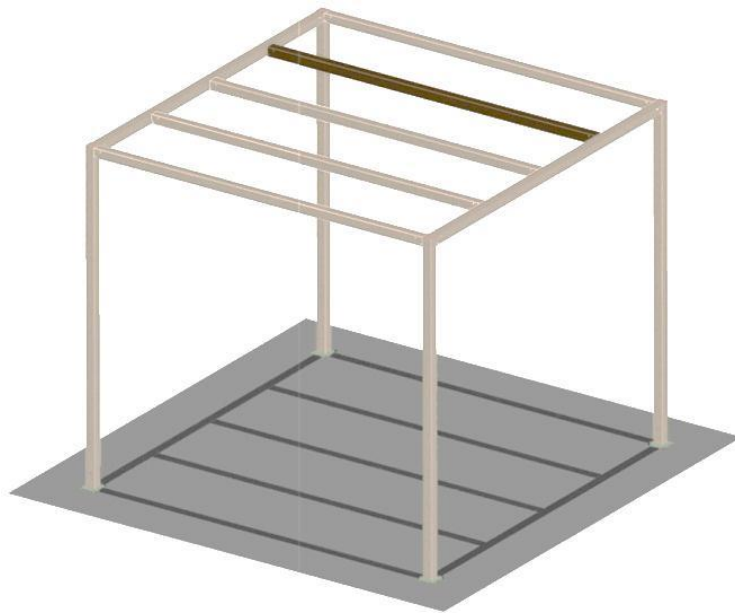

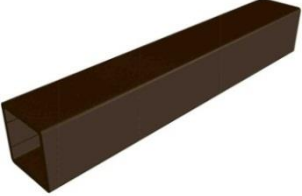
Cantidad	Descripción	Dibujo
3	Perfil Tecnodeck 85x85	
3	Perfil AL 68x68	
1	Base con 8 agujeros [+ tornillos]	
1	Terminal p/montaje en pared [+ tornillos]	
3	Conexión 90° [+ tornillos]	
1	Tapón	
1	Espaciador PE 85x85x5	
Opciones		
1	Brida de acabado con 4 agujeros– Lacada 170x170/2	
	Brida de acabado con 4 agujeros– Acero inoxidable 170x170/2 Inox A4	
18	Tapa atornillada	

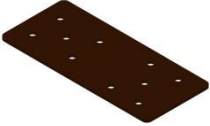
Barras adicionales



Cantidad	Descripción	Dibujo
1	Perfil Tecnodeck 85x85	
1	Perfil AL 68x68	
2	Conexión Plana 85x85 [+ tornillos]	
TOTAL		
8	Tapa atornillada	
2	Conexión 90° [+ tornillos]	
2	Conexión Angular 90° Lateral 85x85 [+ tornillos]	

Barras Adicionales 85x85

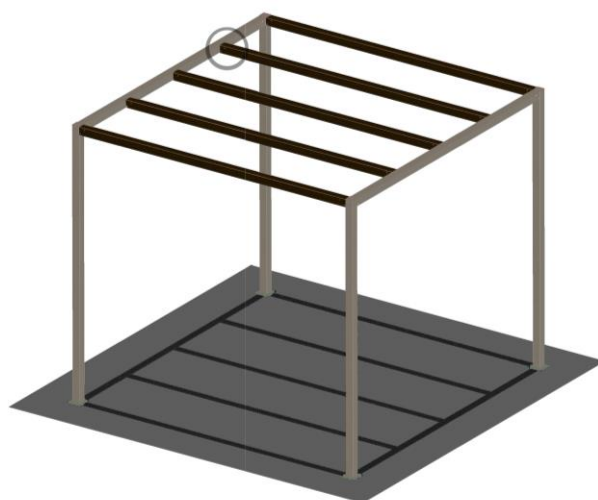

Conexión Plana

Conexión Doble Plana

Conexión Angular

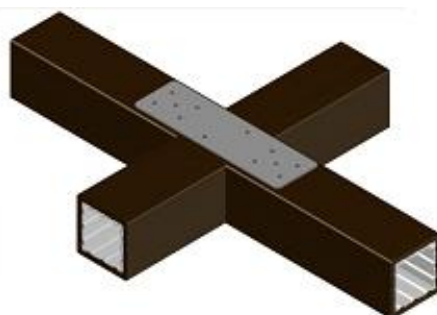
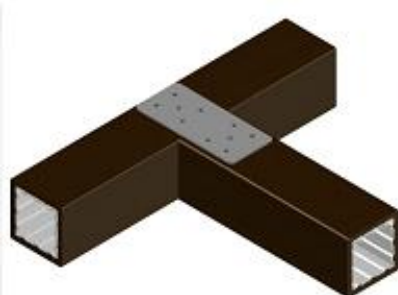

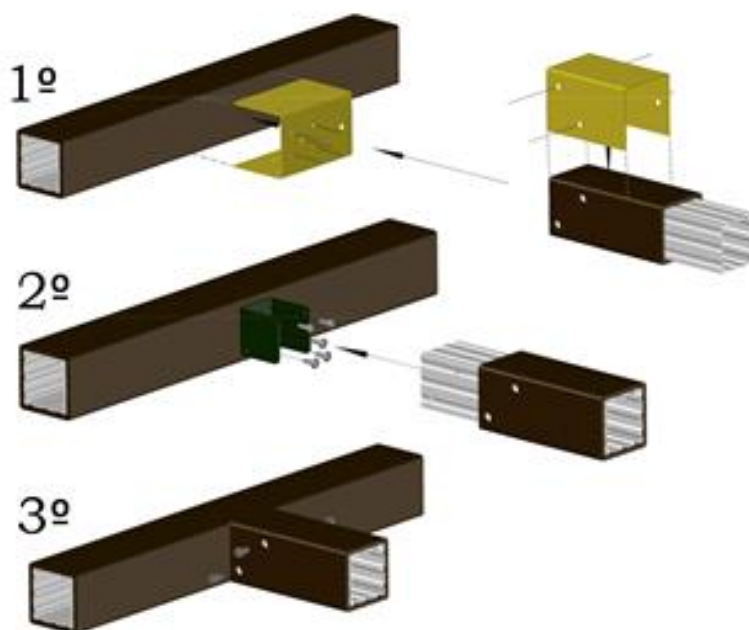

Conexión 90°



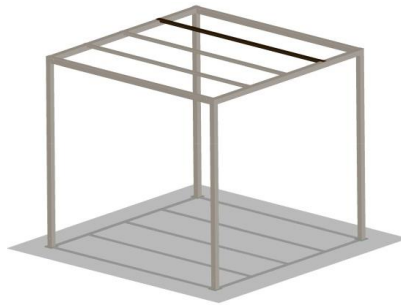

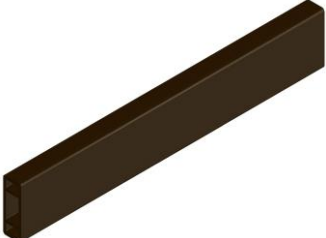
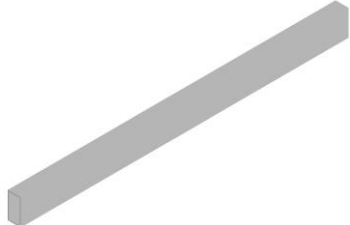
Barras Adicionales 85x30







Cantidad	Descripción	Dibujo
1	Perfil Tecnodeck 85x30	
1	Perfil AL 40x20	
2	Conexión Plana 85x30 [+ tornillos]	
TOTAL		

Barras Adicionales 85x30 Aplicación Vertical

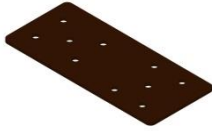
Cantidad	Descripción	Dibujo
1	Conexión Plana Doble 85x30 [+ tornillos]	
2	Conexión 90° 85x30 V [+ tornillos]	

Barras Adicionales 85x30 Aplicación Horizontal

Cantidad	Descripción	Dibujo
2	Conexión Plana 85x85 [+ tornillos]	
1	Conexión Plana Doble 85x85 [+ tornillos]	
2	Conexión 90° Angular 85x85 [+ tornillos]	
2	Conexión 90° 85x30 H [+ tornillos]	

Conexiones Verticales

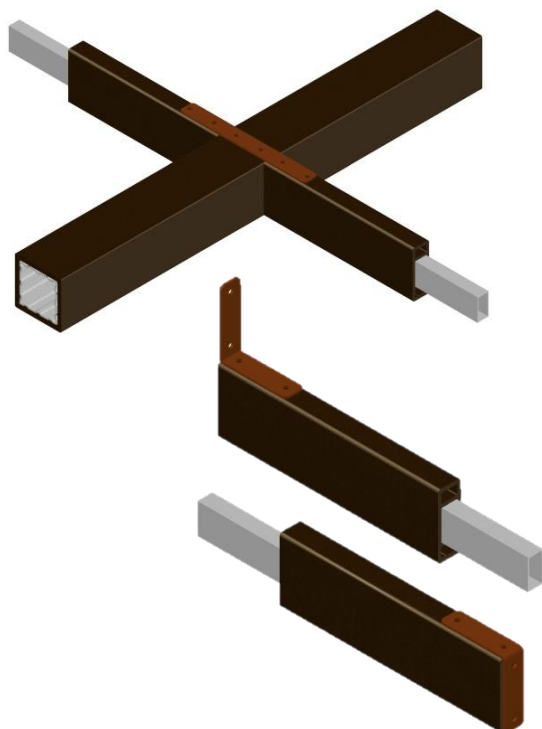

Conexiones Horizontales

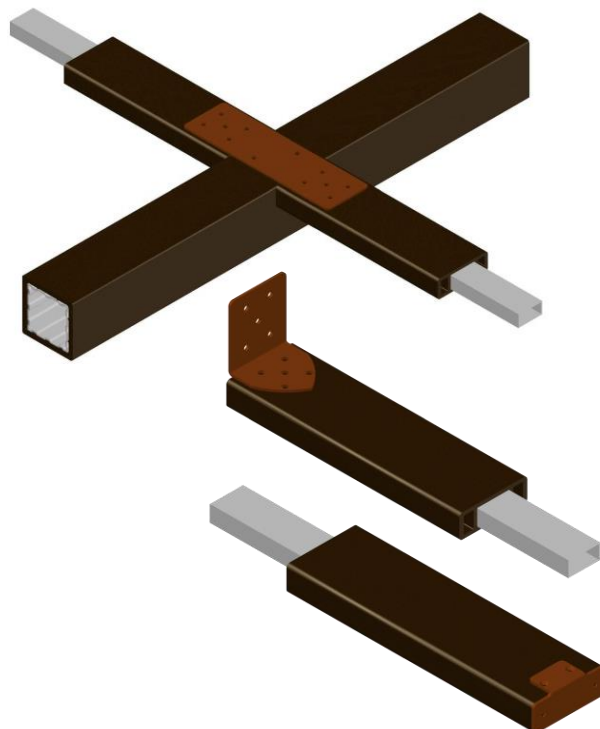

Posicionadores

Cantidad	Descripción	Dibujo
1	Poscionador 85x85	

Perforación nel

- **Perfil Tecnodeck**
- **Perfil ALU**

Ø 9mm

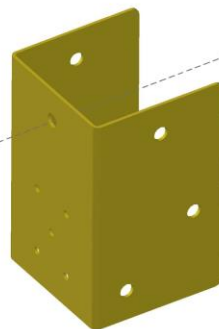

1º



Perforación nel

- **Perfil Tecnodeck**

Ø 15mm



2º

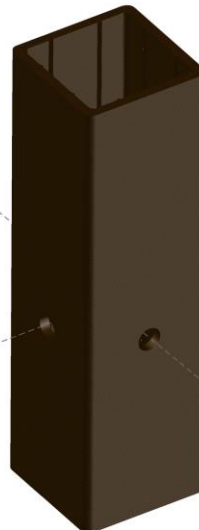

Sistema "Motion"

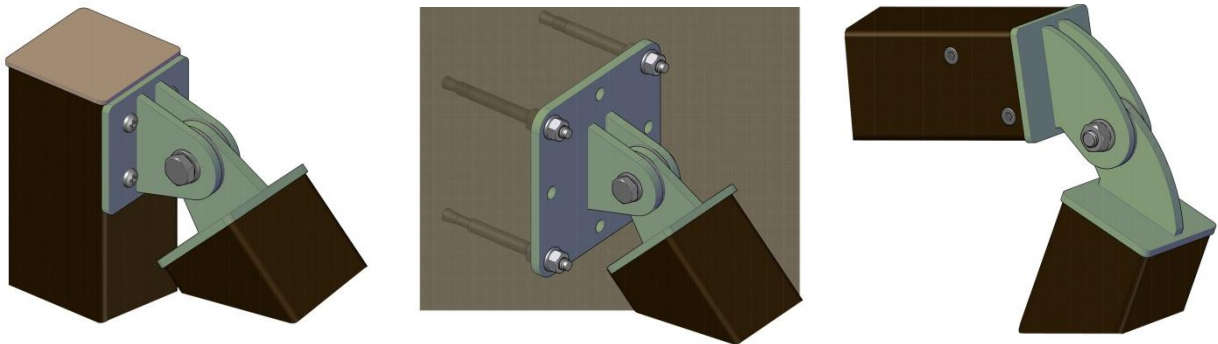

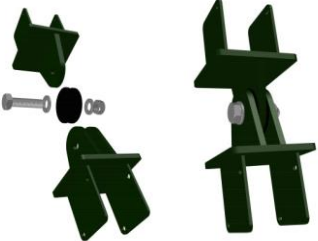
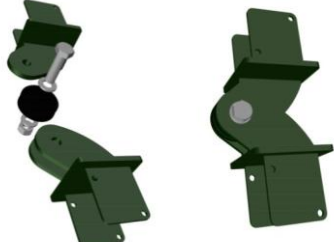
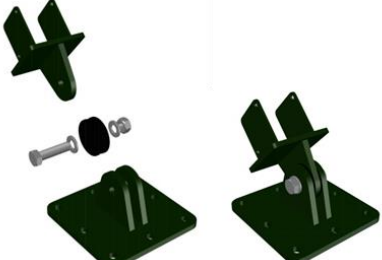
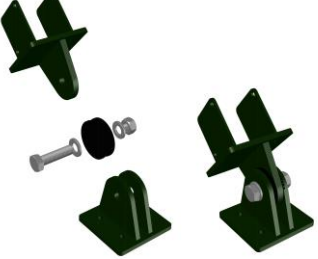
Descripción	Dibujo
<p>Enlace Giratorio Completo, para encajar nel Perfil ALU 68x68</p> <p>0° - 90°</p>	
<p>Enlace Giratorio 270° Completo, para encajar nel Perfil ALU 68x68</p> <p>90° - 180°</p>	
<p>Enlace Giratorio Simple de encajar + Enlace Giratorio doble Fixación al Piso o al Pared</p>	
<p>Enlace Giratorio Simple de encajar + Enlace Giratorio doble Fixación al Poste</p>	

Superficie Ocupada – (footprint) por el Sistema Pérgola: Base Fija

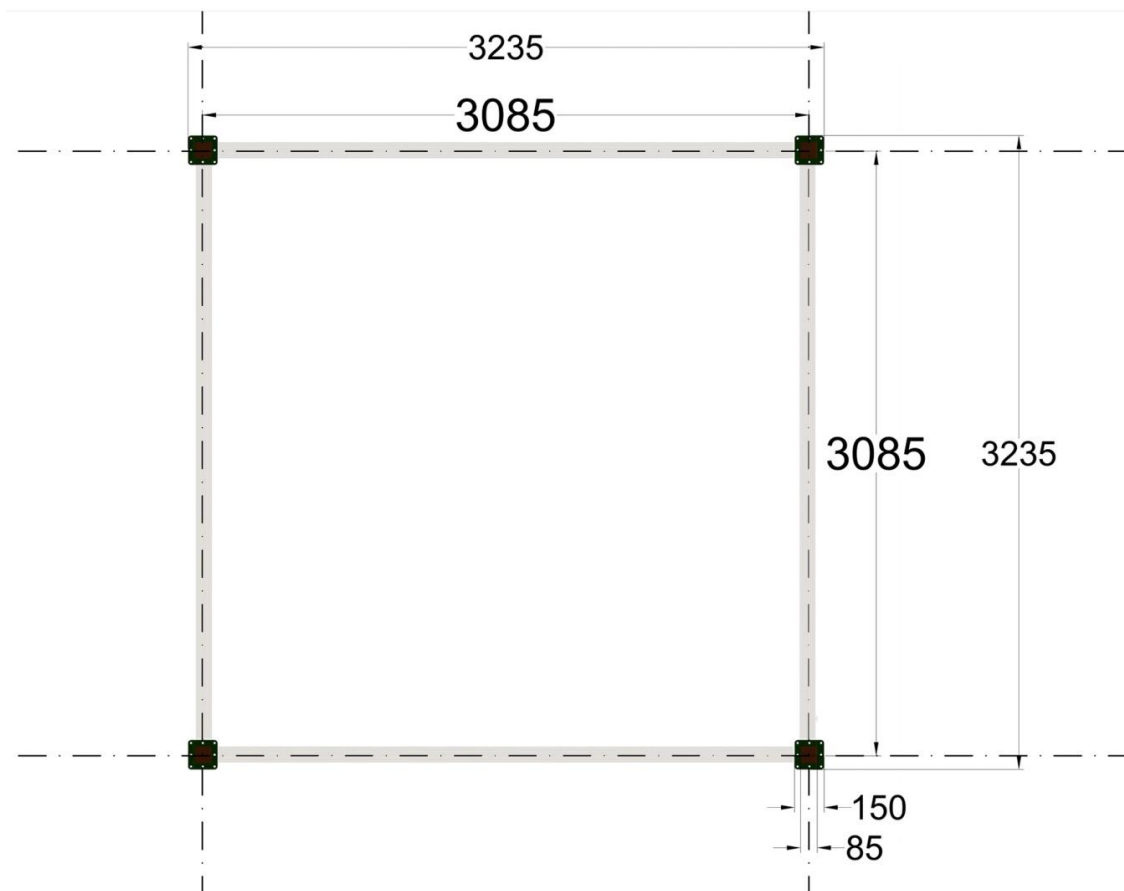

Superficie Ocupada – (footprint) por el Sistema Pérgola: Montaje en la Pared



Sistema Básico Pérgola Base Fija

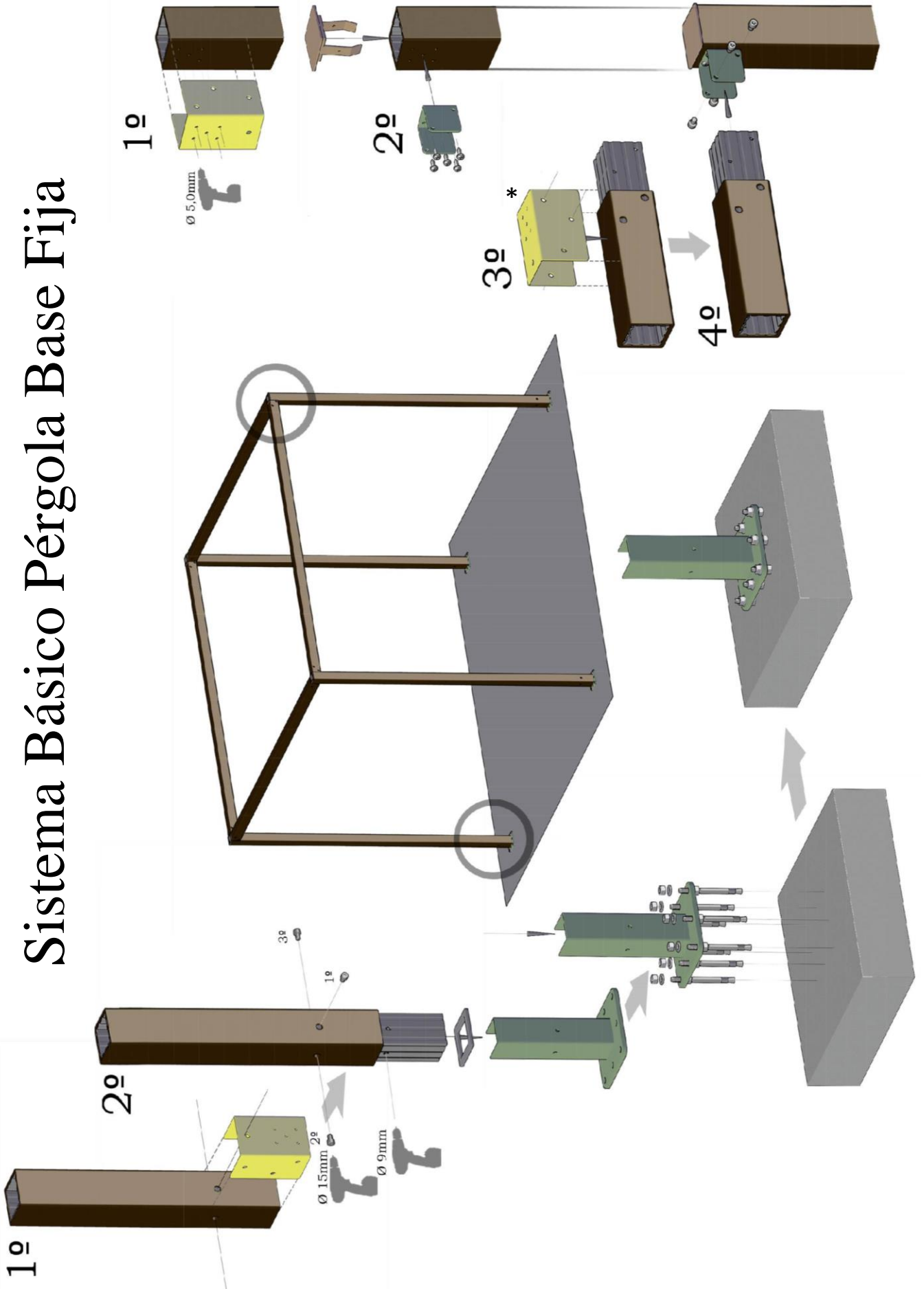

Sistema Básico Pérgola Montaje en la Pared

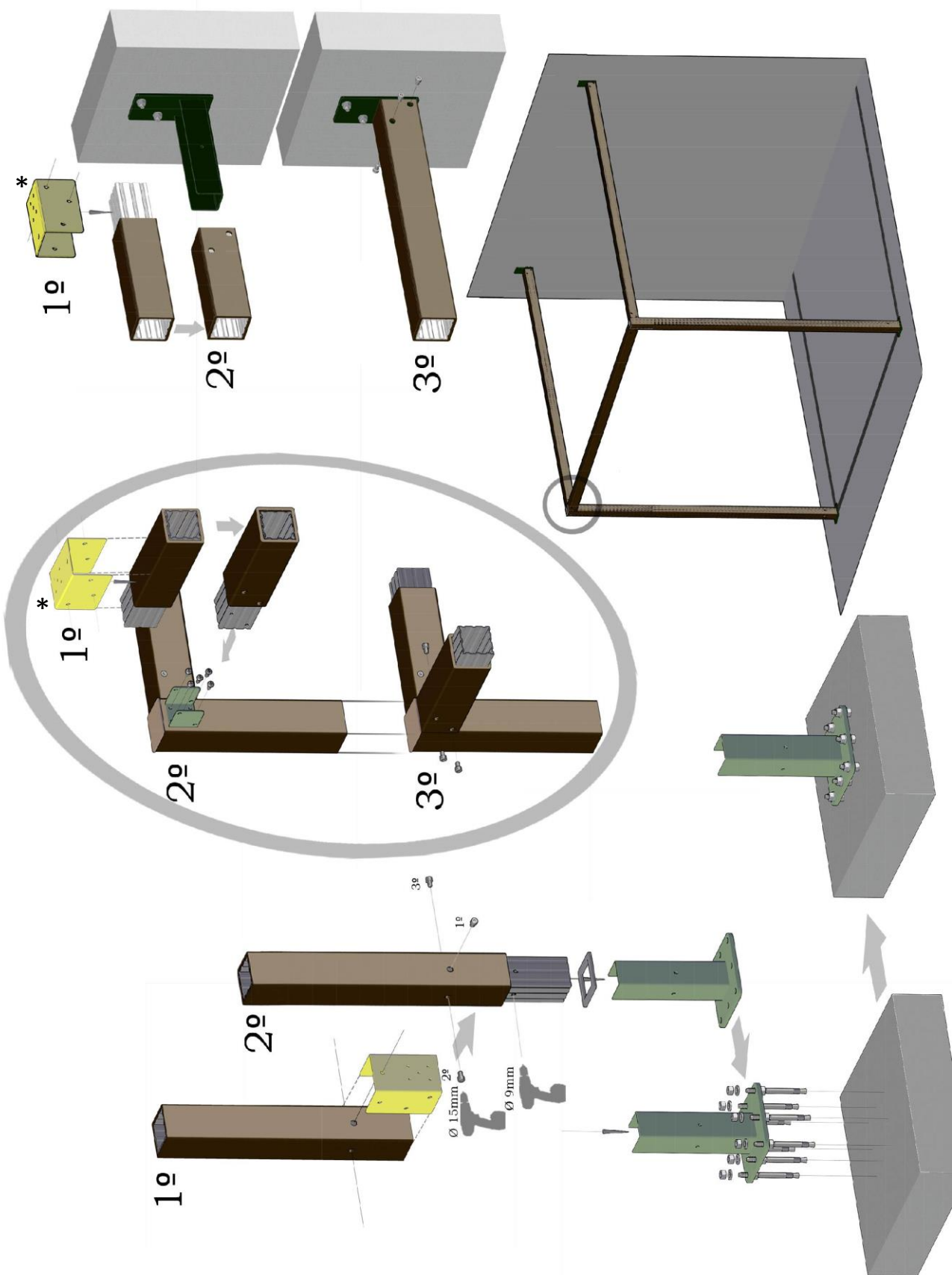

Sistema “Motion”

Pérgola con Enlaces Giratorios

Enlaces Giratorios Fijadas a la Pérgola

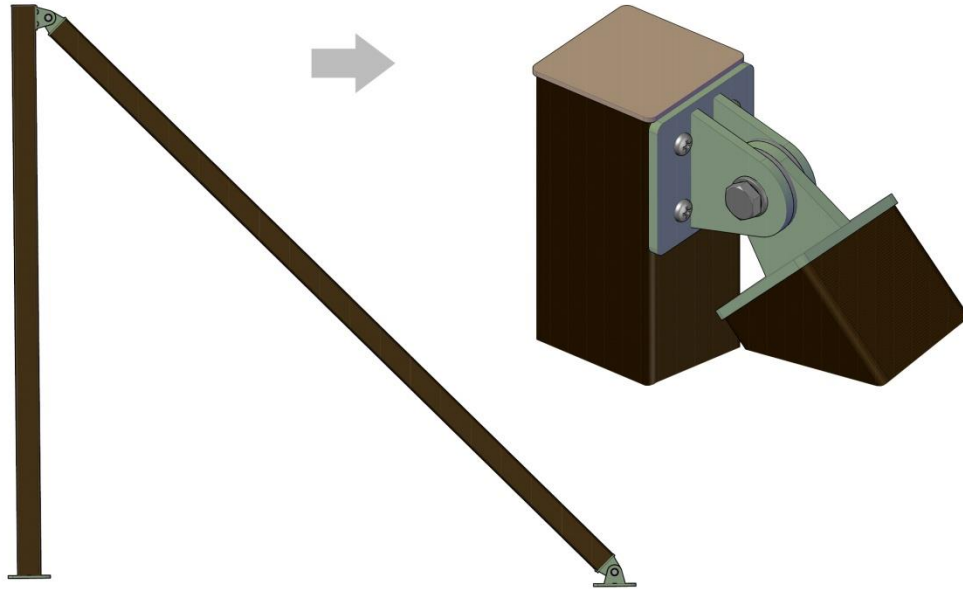

Enlaces Giratorios Fijadas a la Pared

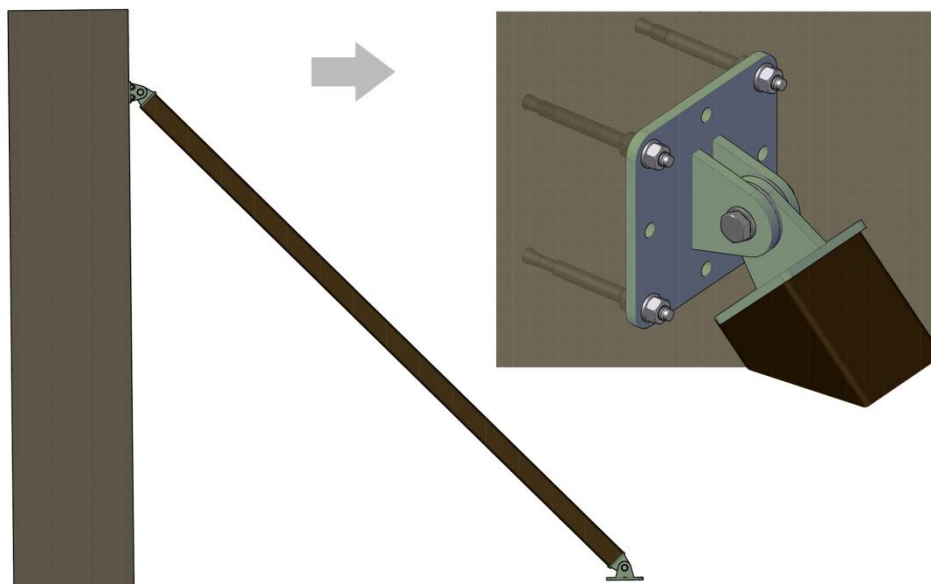

Sistema “Motion”

Pérgola con Enlaces Giratorios

Enlaces Fijados a la Pérgola

